

Installation, Operation, and Maintenance (IOM) Manual for 3-Way Flanged Ball Valves

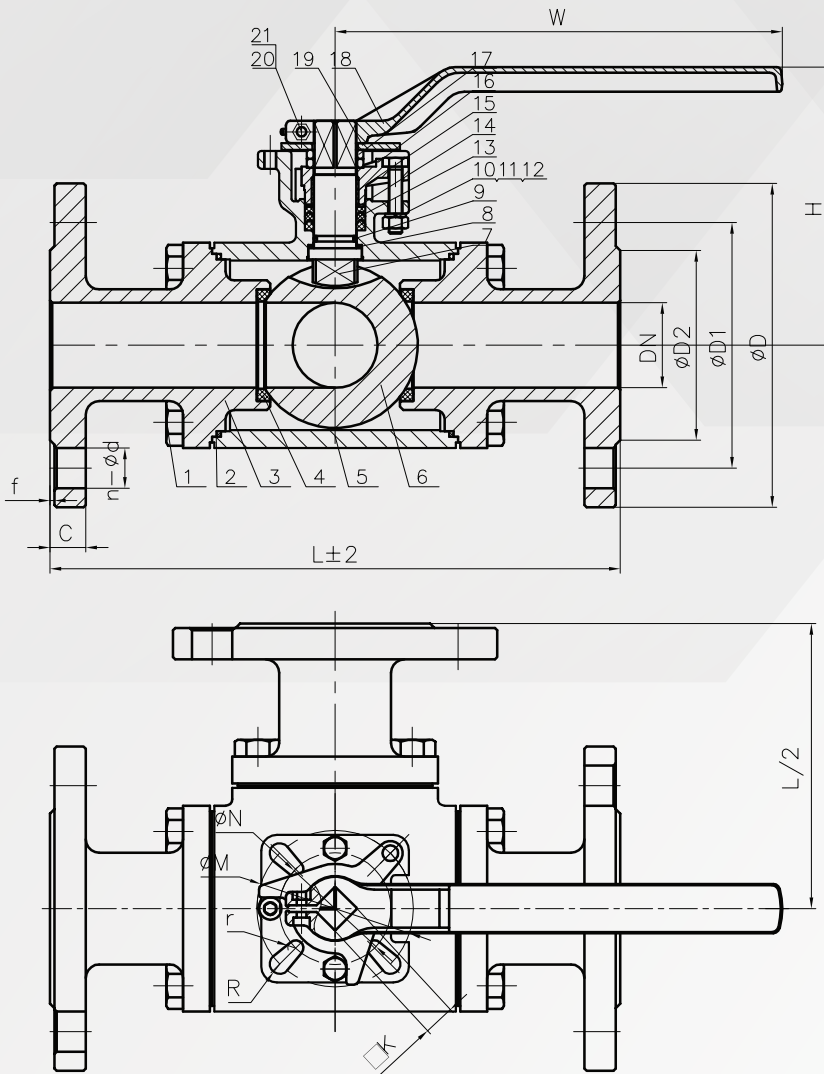

21	NUT
20	HEX SOCKET BOLT
19	STOPPER
18	HANDLE
17	WASHER
16	GLAND
15	BUSHING
14	GASKET
13	PACKING
12	NUT
11	SPRING WASHER
10	BOLT
9	O-RING
8	STEM WASHER
7	STEM
6	BALL
5	BODY
4	SEAT
3	BONNET
2	GASKET
1	BOLT

Refer to the diagram and parts list above for a detailed view of each component, assisting with installation, operation, and maintenance for optimal valve performance.

ANIX[®]

ANIX VALVE CO.LTD, Certified ISO 9001.
www.anixusa.com

T-PORT 90 TURN

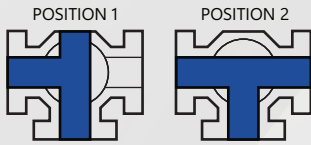

FLOW PLAN 1

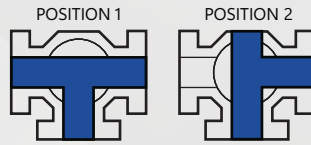

FLOW PLAN 2

L-PORT 90 TURN

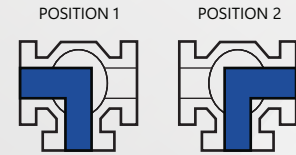

FLOW PLAN 9

L-PORT 180 TURN

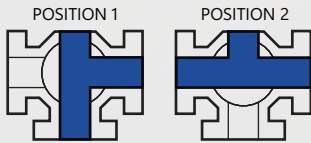

FLOW PLAN 3

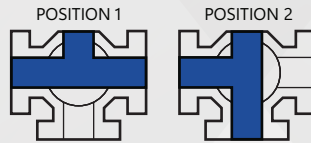

FLOW PLAN 4



FLOW PLAN 10

T-PORT 180 TURN



FLOW PLAN 5



FLOW PLAN 6



FLOW PLAN 7



FLOW PLAN 8



ANIX VALVE CO.LTD, Certified ISO 9001.
www.anixusa.com

Note: This document is a general guideline for the installation, operation, and maintenance of Flanged 3-Way Ball Valves, intended to assist trained personnel in following recommended procedures. It is not an exhaustive set of instructions. Carefully read the manual for safe and efficient use. We are not liable for damages arising from its use. Consult a professional if you have specific concerns related to your application or environment. For additional assistance, contact your supplier or representative.

PRODUCT OVERVIEW

- The 3-Way Flanged Ball Valve is engineered for versatile flow control and directional switching in industrial applications, making it ideal for processes that require consistent and reliable flow direction changes. This valve features a robust body with three ports, enabling two flow configurations:
 - L-Port: Directs flow between two of three ports, typically for diverting applications.
 - T-Port: Allows for mixing or diverting functions, connecting all three ports simultaneously or isolating one of them, ideal for distributing flow among different lines.
-

INSTALLATION PROCEDURE

- **Preparation**
 - **Ensure Safety:** Before installation, ensure all operating lines are shut off, and the valve site is isolated from the process. Depressurize and drain the process fluid.
 - **Inspect the Valve:** Check the valve for any external damage or foreign materials. Ensure the valve is clean and free of any debris that could damage the internal components during operation.





ANIX VALVE CO.LTD, Certified ISO 9001.
www.anixusa.com

- **Positioning and Fastening**

- **Pipe Alignment:** The valve should be installed between two flanges with proper alignment. Ensure the pipeline is properly supported and does not exert tension on the valve body during installation.
- **Valve Orientation:** Install the valve with the flow ports aligned according to the desired flow path. Ensure the valve is in the open position to prevent seat and ball damage.
- **Flange Connection:** Use appropriate flange gaskets (not included) and tighten bolts according to the recommended torque settings.
- **Seals and Covers:** Protective end caps should be removed immediately before installation to avoid contamination. Ensure the valve's flanges are free from any dirt or debris that could cause leakage.
- **Flange Compatibility:** Verify that the flange dimensions match the valve specifications to ensure proper sealing.

- **Actuator Alignment (if applicable)**

- If the valve is equipped with an actuator, ensure that the actuator is aligned correctly with the valve stem and securely fastened.
- Verify the actuator's settings and compatibility with the valve before operation.

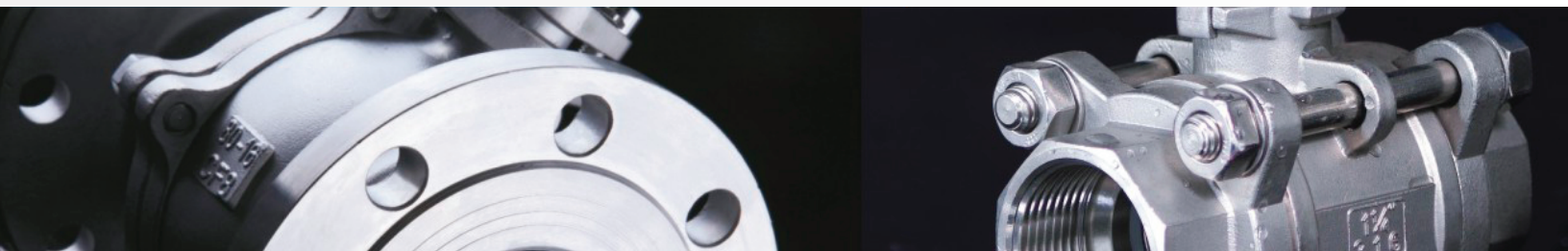



ANIX VALVE CO.LTD, Certified ISO 9001.
www.anixusa.com

OPERATION

- Manual Operation:
 - For manual operation, turn the handle to move the valve between its open and closed positions. The valve requires a one-quarter turn (90°) to switch between positions.
 - Port Position Indicator: The valve features visual markings on the stem to indicate the flow path configuration (i.e., port positions).
- Handle Operation
 - The manual handle should be turned in a consistent motion. Avoid excessive force to prevent damage to the stem or the valve mechanism.
- Automated Operation
 - Actuator Setup: For automated valves, ensure the actuator is properly wired and calibrated according to the manufacturer's guidelines.
 - Control System: Automated systems should be integrated with the valve in accordance with the flow requirements. Refer to the actuator manufacturer's manual for more details on automation specifics.

MAINTENANCE

- Preparation for Maintenance
 - Ensure the valve is in the open position to release any trapped pressure within the valve body. Depressurize the pipeline and drain the fluid before proceeding with maintenance work.
 - Wear personal protective equipment (PPE) to safeguard against accidental fluid discharge or valve component contact
- Stem Packing Adjustment
 - Leakage at Stem: If leakage occurs at the stem, slightly tighten the packing gland bolts. Adjust in small increments (e.g., one-quarter turn) to avoid over-tightening.
 - Packing Replacement: If leakage persists, replace the stem packing. Ensure the new packing is properly seated before reassembly.



ANIX VALVE CO.LTD, Certified ISO 9001.

www.anixusa.com

▪ Valve Disassembly

- Step-by-Step Disassembly:
 - Ensure the valve is in the full open position before removal from the pipeline.
 - Carefully remove the bolts securing the end caps and separate them from the valve body.
 - Remove the ball, stem, and seats from the valve body. Examine all internal components for wear or damage.
 - Clean all parts thoroughly before inspection.

▪ Valve Reassembly

- Reassemble in Reverse Order: Reinstall the cleaned or replaced components, including the stem, ball, and end caps.
- Seal Placement: Ensure the seals and gaskets are correctly placed in their respective grooves.
- Bolt Tightening: Tighten all bolts gradually, ensuring an even seal around the valve body.
- Testing: After reassembly, operate the valve manually to ensure smooth operation. If necessary, conduct a leak test to confirm proper sealing.

TROUBLESHOOTING

▪ Stem Leakage

- Solution: If leakage occurs at the stem, first try adjusting the packing gland bolts. If leakage persists, replace the stem packing.

▪ Body Seal Leakage

- Solution: Inspect the body nuts and tighten as needed. If leakage continues, replace the body seal.

▪ In-Line or Seat Leakage

- Solution: Ensure the valve is in the full position and check the flow configuration. If leakage persists, inspect the seats for wear and replace if necessary.



ANIX VALVE CO.LTD, Certified ISO 9001.
www.anixusa.com

STORAGE AND HANDLING

- **Short-Term Storage:** If the valve is not being immediately installed, store it in its original packaging, in a dry and clean environment. Ensure the valve remains in the open position during storage.
- **Long-Term Storage:** For long-term storage, inspect the valve every six months. Clean and lubricate the internal components before reinstallation.

ADDITIONAL NOTES

- **Valve Modification:** Do not modify the valve or its components without manufacturer approval. Any unauthorized modifications may void the warranty and affect valve performance.
- **Spare Parts:** Always use manufacturer-recommended spare parts for maintenance. Ensure parts are compatible with the valve model to avoid issues during operation.

